

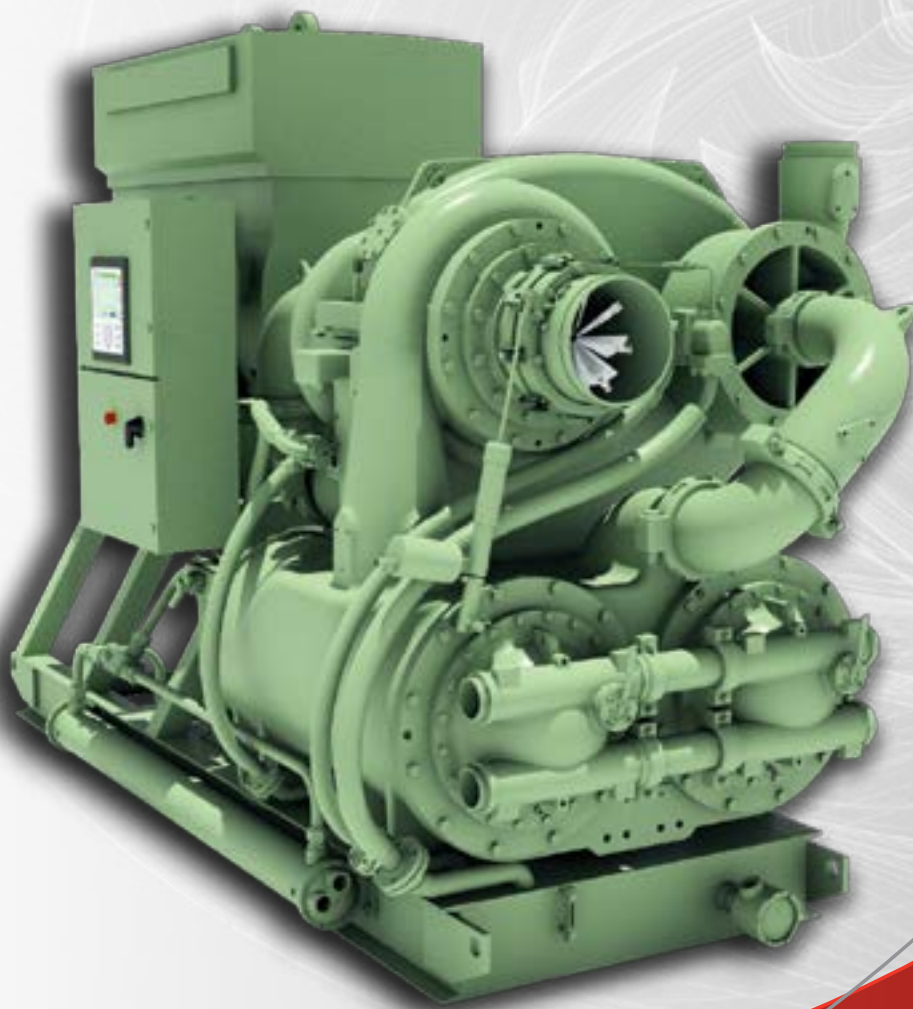

TURBO-AIR NX 8000 Centrifugal Compressor

100% oil-free air*

**Per ISO 8573-1 certification*



Same Engineered Quality, All New Compressor

Ingersoll Rand has a long-standing tradition of providing innovative products and technology that positively affect our customers' bottom line. Following this tradition, Ingersoll Rand is proud to introduce the new TURBO-AIR® NX 8000, a centrifugal compressor designed to meet the highest performance and reliability standards. These high standards were achieved by incorporating robust design features that increase flow and optimize efficiency in a compact footprint.

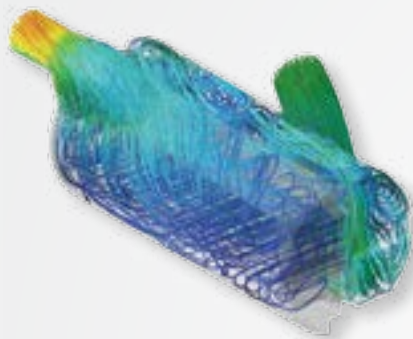

Featured Improvements





- Integrated structural sub-base also serves as lubricant reservoir, drive motor foundation, and mounting platform for lube system accessories, including the aux oil pump, oil heater, and oil cooler.
- Optimized stage and gas passages utilizing computational fluid dynamics (CFD)
- OEM-optimized cast-in-water manifold, with provisions for optional patent-pending integral trim valves
- Interchangeable intercooler bundles

ISO Certified Class Zero

Our TURBO-AIR centrifugal compressor product line has been engineered to produce oil-free air for more than 60 years. This certification officially acknowledges the ability of our compressors to produce 100% oil-free air, providing our customers with enhanced quality assurance.



Compare the innovative centrifugal compressor technology of the TURBO-AIR NX 8000 with other compressors, and the advantages are clear.

TURBO-AIR COMPRESSORS	OTHER COMPRESSORS
 LOW MAINTENANCE <ul style="list-style-type: none"> • Compression elements do not wear or require periodic replacement • Oil filter elements are easily replaced • Bearings designed for extended life 	<ul style="list-style-type: none"> • Require regular maintenance and periodic replacement of air ends • Result in high operating expenses and significant machine downtime
 OIL-FREE AIR <ul style="list-style-type: none"> • 100% oil free per ISO 8573-1 certification • Prevent contamination of system 	<ul style="list-style-type: none"> • Oil filters must be installed at discharge • Potential for oil carryover that fouls the process • Oil-free claim is dependent on uninterrupted seal gas supply
 HIGH RELIABILITY <ul style="list-style-type: none"> • Centrifugal compressors are proven to have a long mean time between failures (MTBF), and independent research has shown an industry-leading availability of 99.7% • Conservative high-quality gear design 	<ul style="list-style-type: none"> • Contacting compression elements are subject to wear • Limited rotating element life • Designed-in wearing items to generate aftermarket revenues
 OPTIMUM CONTROL <ul style="list-style-type: none"> • Automatic operation for any operating condition • State-of-the-art MAESTRO™ suite of controls • PLC control available 	<ul style="list-style-type: none"> • Limited control capability • Costly, high-maintenance variable speed configurations
 NO VIBRATION <ul style="list-style-type: none"> • Essentially vibration-free • No special foundation is required 	<ul style="list-style-type: none"> • Special foundations needed to handle heavy weight • Precautions must be taken to prevent transmission of vibration to other equipment

TURBO-AIR NX 8000 Centrifugal Compressor

Efficient Package

The TURBO-AIR NX 8000 centrifugal compressor features easy, low-cost installation and operation. Select from over 36 pre-engineered aerodynamic configurations, or have us design a custom-engineered aero for an exact match to your operating requirements. One-, two- or three-stage designs available.

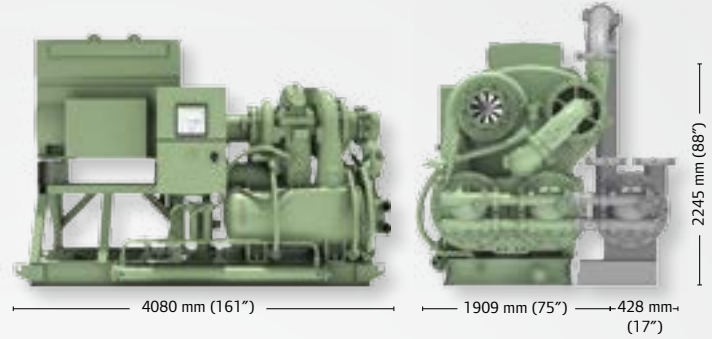

Compressor Motor Sizes Available

750 to 1700 kW (1000 to 2250 hp)

Compressor Discharge Pressure Range

2.5 to 14.5 barg (35 to 210 psig)

Compressor Flow Range

135 to 305 m³/min (4850 to 10,800 CFM)

Typical Package Weight*

11,340 kg (25,000 lb) *driver dependent

Low Total Cost of Ownership

Over time, the energy required to power a compressed air system is the largest cost associated with a compressor; particularly in today's fluctuating energy markets. That is why, to accurately determine the return on your investment, it is important to consider the total life-cycle cost of operating the compressor, including the initial investment, energy consumption and maintenance costs.

As the chart below demonstrates, the TURBO-AIR NX 8000 provides some of the lowest total life-cycle costs of any compressor.

The power savings delivered can significantly speed up the payback on your initial investment, and the savings continue to build the more you use the TURBO-AIR NX 8000.

Typical Performance Curve for 1700 kW (2250 hp) / 8.6 barg (125 psig)

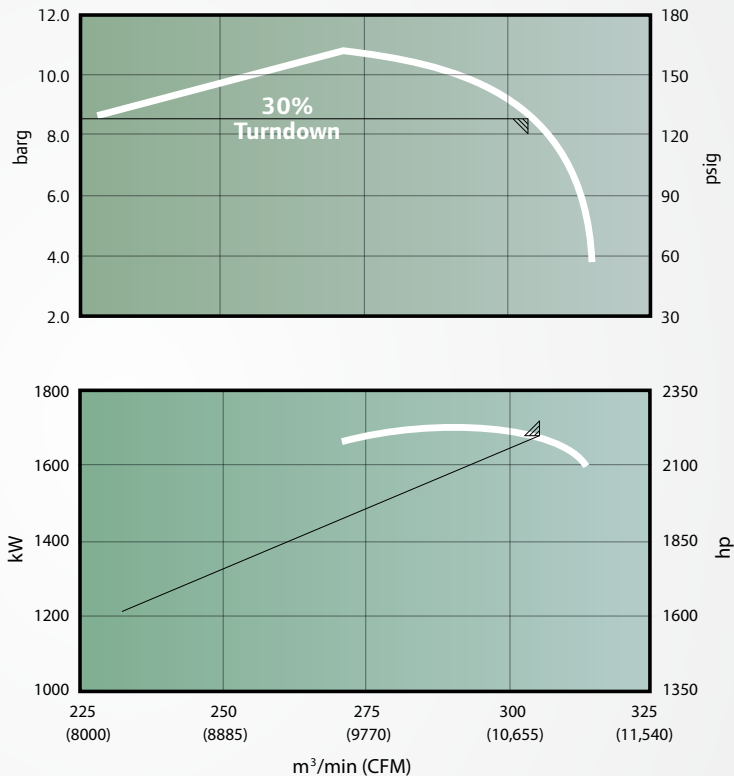

Life-Cycle Cost Comparison

(more than 10 years of operation at 80% loaded)

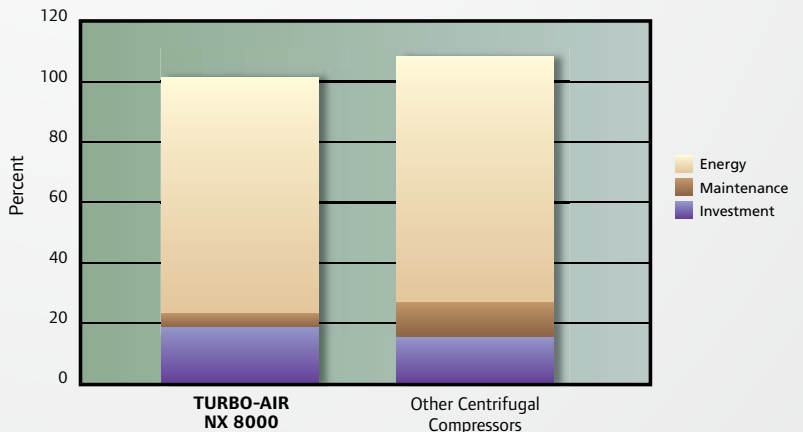

TURBO-AIR NX 8000 Centrifugal Compressor

Features and Benefits

The TURBO-AIR NX 8000 centrifugal compressor is newly improved, with a variety of upgraded features.

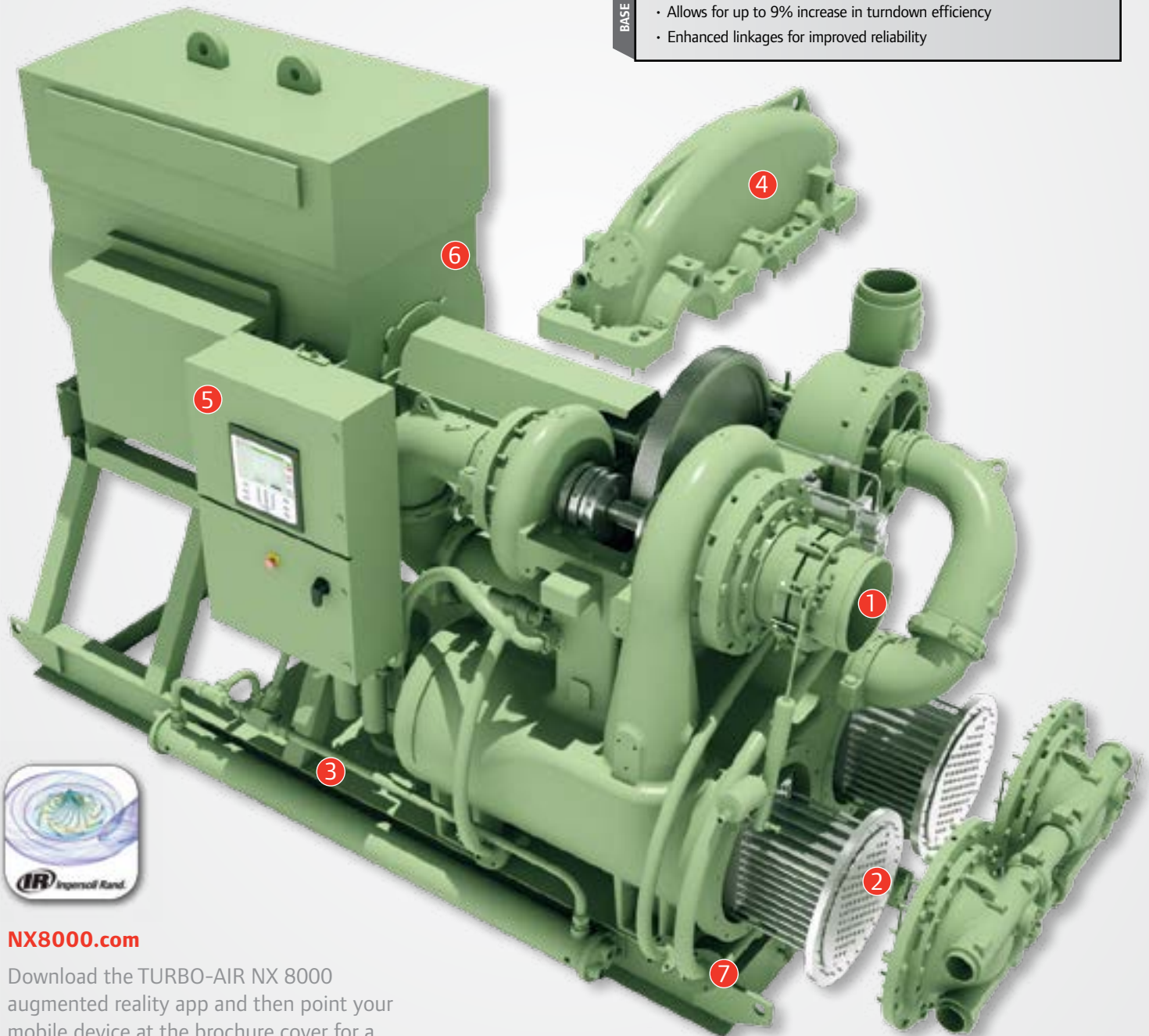

NX8000.com

Download the TURBO-AIR NX 8000 augmented reality app and then point your mobile device at the brochure cover for a virtual product experience.

INTERCOOLERS/WATER MANIFOLD



2

BASE

- Roddable-in-place, straight-tube design
- Optimized heat-transfer surface for premium performance
- Factory-designed and proven integrated water manifold
- Single-point customer water connection for ease of install

UPGRADE

- Coolant trim valve to reduce wasted energy

MAESTRO UNIVERSAL SP CONTROLS



5

BASE

- Automatic and precise pressure/flow regulation
- User selectable energy-saving control modes
- Single Point (SP) – simplifies site electrical installation and maintenance work

UPGRADE

- Interstage pressure and temperature monitoring
- X, Y, axial and keyphasor monitoring

LUBRICATION SYSTEM



3

BASE

- Duplex filter for improved uptime
- Top-mounted components and SAE connections reduce the potential for leakage
- Temperature control valve

UPGRADE

- Twin oil cooler design

PACKAGED HIGH-EFFICIENCY DRIVER



6

BASE

- Reduced energy costs
- Selected to meet site-specific requirements

HORIZONTALLY SPLIT GEARBOX



4

BASE

- Built-in inspection portals
- Easy access for periodic maintenance

CONDENSATE REMOVAL/CORROSION PROTECTION



7

BASE

- High-gloss, industrial-grade, epoxy-based exterior paint
- Cooler cavities protected with special epoxy coating
- Co-location of condensate removal channels for simplified connection and routing of drains and piping

ROBUST AIR END AND ROTATING COMPONENT DESIGN

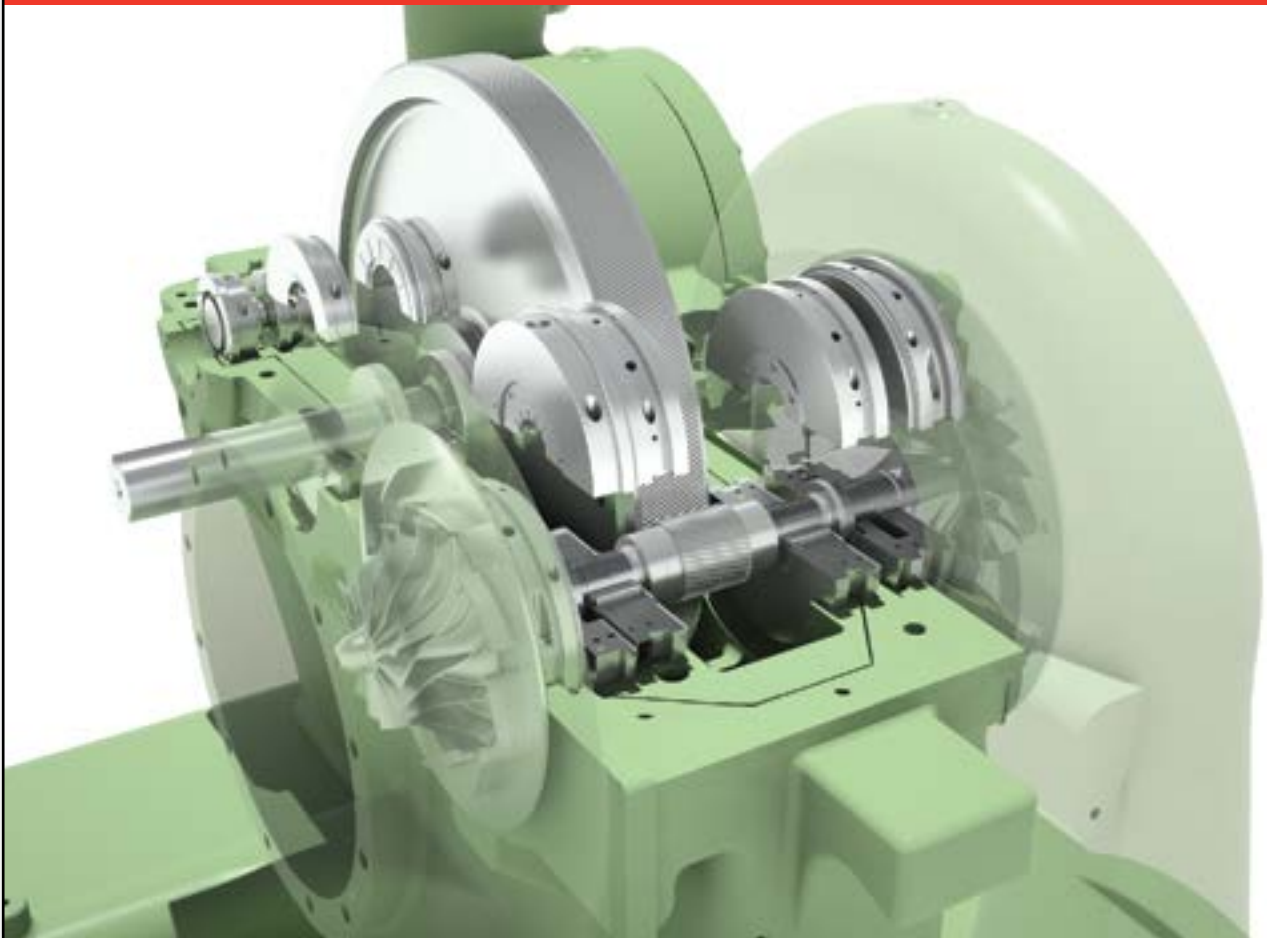

BASE

- High-efficiency AGMA 13 gearing
- Five-axis milled impellers
- Split seal and bearing design for ease of inspection
- Non-contacting air and oil seals
- Stainless steel rotating compression elements
- Optimized low-solidity diffusers
- Integral scrolls ensure precise concentricity and gear alignment

HARDWARE-FREE, INTERLOCKING AIR AND OIL SEALS

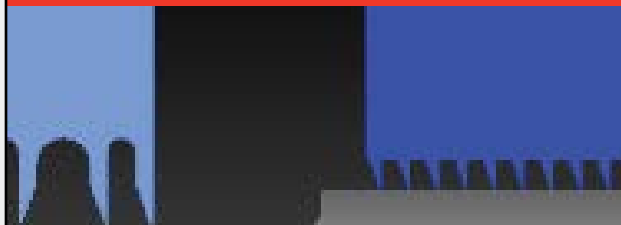

Non-contacting, non-wearing labyrinth air and oil seals, with atmospheric air gap, require no buffer air for oil-free air, and eliminate the need for periodic replacement of carbon-ring seals and instrument air for permissive starting

TILTING PAD JOURNAL BEARING AND TAPERED LAND THRUST BEARING



Independent thrust and journal bearings enhance mechanical reliability for a wide range of loads and eliminate hot oil carryover, reducing bearing pad temperatures. Thrust bearing designed to limit axial rotor float, enabling high stage efficiency.

Your Trusted Partner in Compressed Air

Optimize your total **Cost** of ownership, while maximizing **Availability**, **Reliability** and **Efficiency** throughout the life of your compressed air system with our Lifecycle CARE services.

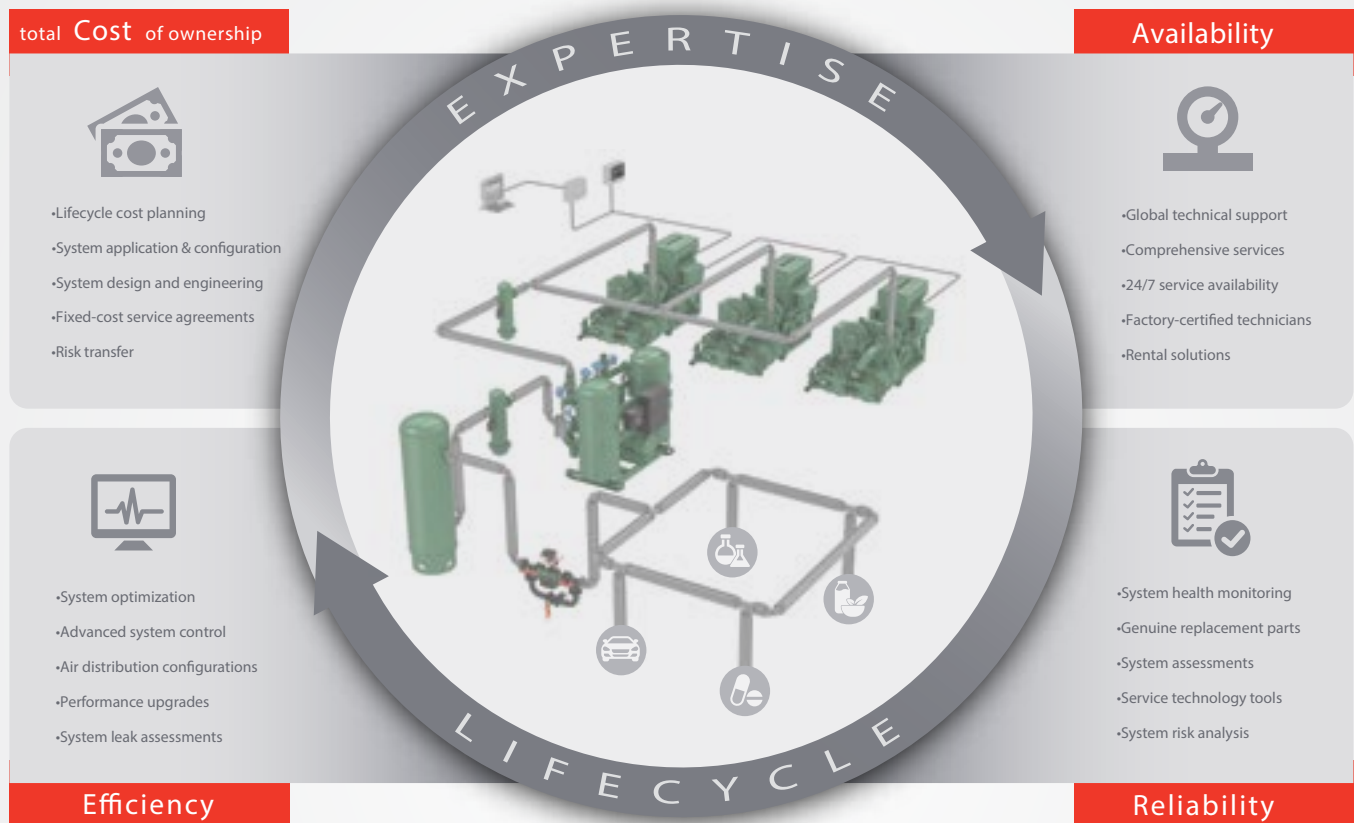

Design • Install • Commission • Operate • Maintain • Extend

PackageCARE™ ...eliminate the inconvenience

No matter where your facility is located, Ingersoll Rand is committed to serving you 24 hours a day, seven days a week, and is available to support you with innovative, cost-effective service solutions that will keep you running at peak performance. Let Ingersoll Rand handle the pressures and responsibilities of owning a compressed air system with our signature service contract.





Ingersoll Rand (NYSE:IR) advances the quality of life by creating comfortable, sustainable and efficient environments. Our people and our family of brands—including Club Car®, Ingersoll Rand®, Thermo King® and Trane®—work together to enhance the quality and comfort of air in homes and buildings; transport and protect food and perishables; and increase industrial productivity and efficiency. We are a \$13 billion global business committed to a world of sustainable progress and enduring results.



centrifugal.ingersollrand.com

Distributed by:

Ingersoll Rand, IR, the IR logo, PackageCARE, TURBO-AIR and MAESTRO are trademarks of Ingersoll Rand, its subsidiaries and/or affiliates. All other trademarks are the property of their respective owners.

Nothing contained on these pages is intended to extend any warranty or representation, expressed or implied, regarding the product described herein. Any such warranties or other terms and conditions of sale of products shall be in accordance with Ingersoll Rand's standard terms and conditions of sale for such products, which are available upon request.

Product improvement is a continuing goal at Ingersoll Rand. Any designs, diagrams, pictures, photographs and specifications contained within this document are for representative purposes only and may include optional scope and/or functionality and are subject to change without notice or obligation.